

# VILOT

Art.-Nr.

404 584  
404 585  
404 588  
404 589

900  
1910  
350  
mm

1/8  
VO  
51-2024

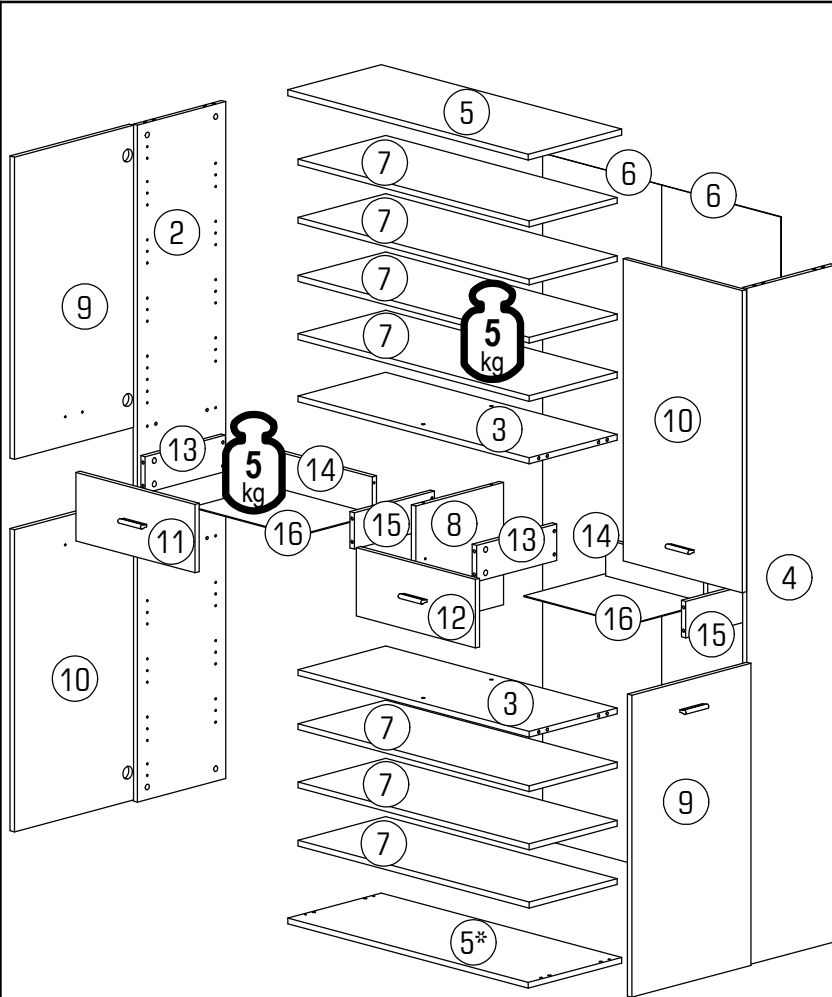
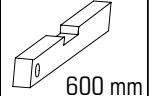
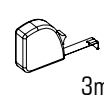
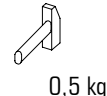
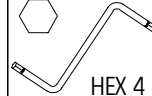
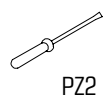
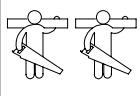

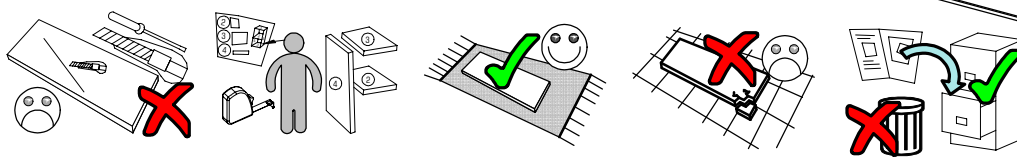
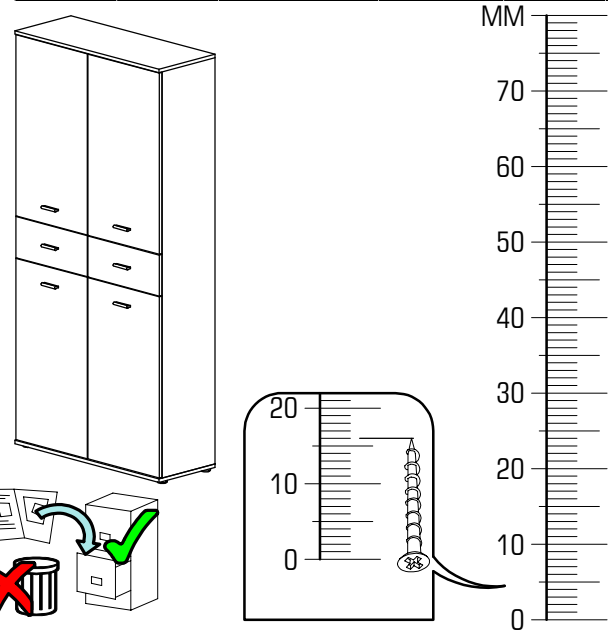

ID	ID	Dimensions	Quantity	Ratio
18151	②	1860*330*16	1x	1/2
18038	③	866*329*16	2x	2/2
18064	④	1860*330*16	1x	1/2
18062	⑤	900*350*16	2x	2/2
18066	⑥	1886*446*3	2x	1/2
18061	⑦	866*329*16	7x	2/2
18060	⑧	336*329*16	1x	2/2
18059	⑨	830*446*16	2x	1/2
18058	⑩	830*446*16	2x	1/2
18169	⑪	446*188*16	1x	1/2
18109	⑫	446*188*16	1x	1/2
18819	⑬	300*100*16	2x	2/2
18072	⑭	367*100*16	2x	2/2
18822	⑮	300*100*16	2x	2/2
18048	⑯	306*397*3	2x	2/2



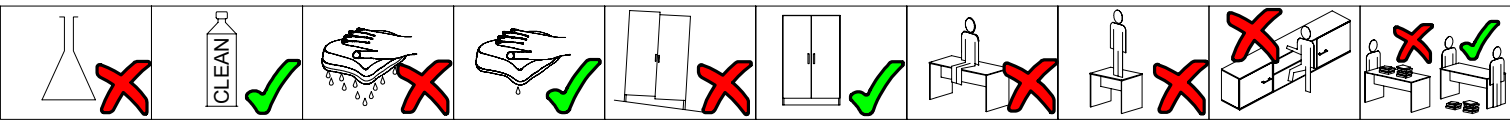



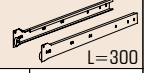
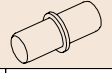
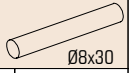
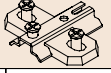
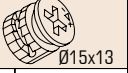
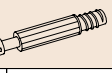

21102.00	Ø1,6x20	22213.00	Ø4x70	22240.02	Ø3,5x15	22244.01	Ø3,5x16	22250.00	Ø4x25	33003.00	L=300	22280.00	Ø4x30	22300.00	Ø7x50	35101.01	
B	75x	C	1x	D	32x	E	8x	F	4x	G	2x	H	12x	J	12x	K	28x
24103.00	Ø8	27000.00	Ø8x30	31103.00		36002.07		36002.07		70013.01	Ø15x13	70021.01		22705.00	Ø6,8x8	33003.00	L=300
L	1x	M	16x	N	1x	P	8x	Q	8x	R	24x	S	24x	T	8x	U	2x
30080.00		32314.01	Ø44x15														
V	24x	W	4x	X	6x												

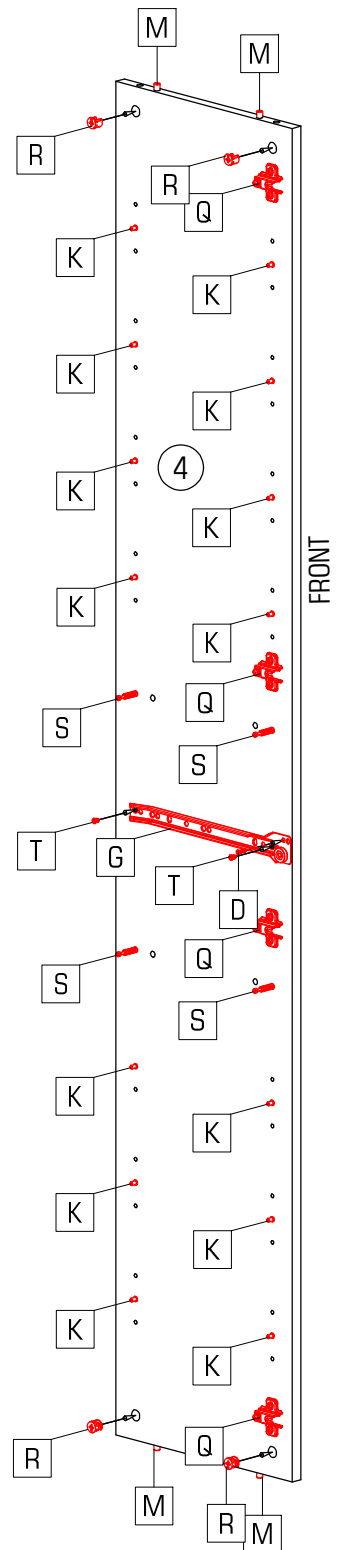
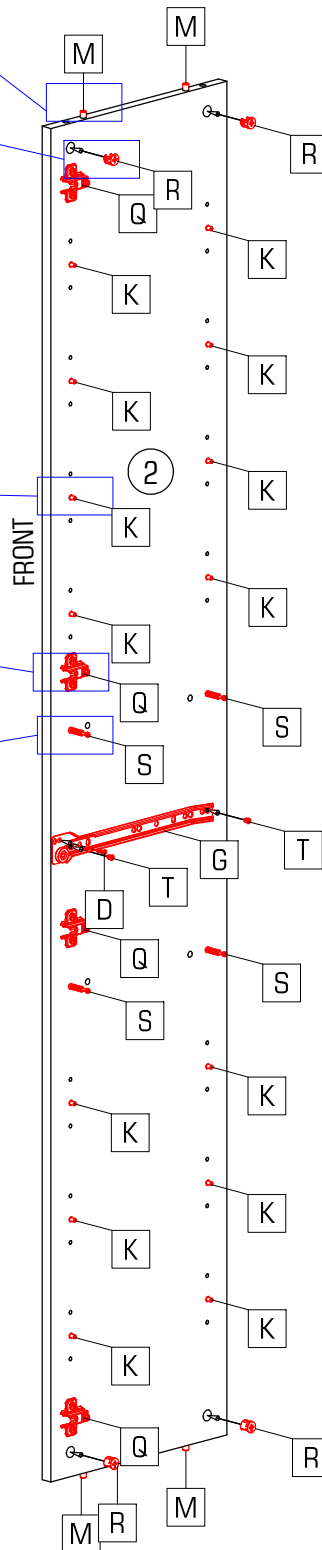
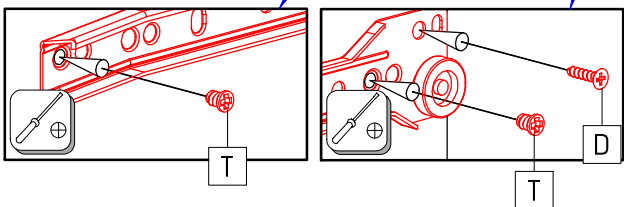
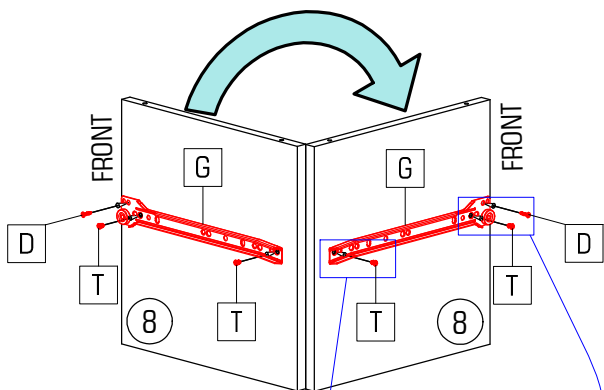
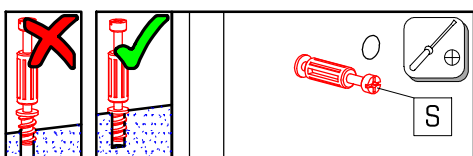
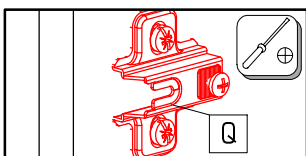
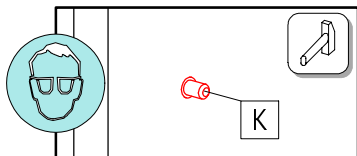
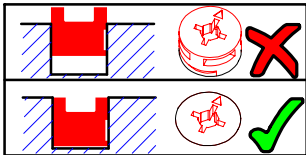
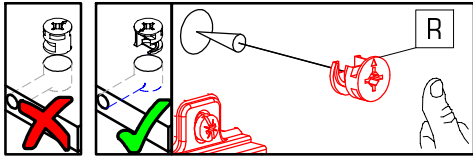
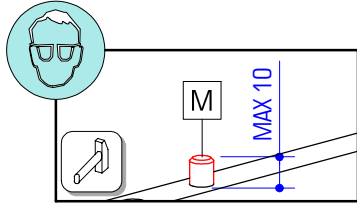

# 2/8 VILOT

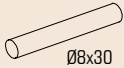
							
D	G	K	M	Q	R	S	T
4x	2x	28x	8x	8x	8x	8x	8x

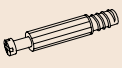

				
F 4x	M 8x	R 8x	S 8x	W 4x

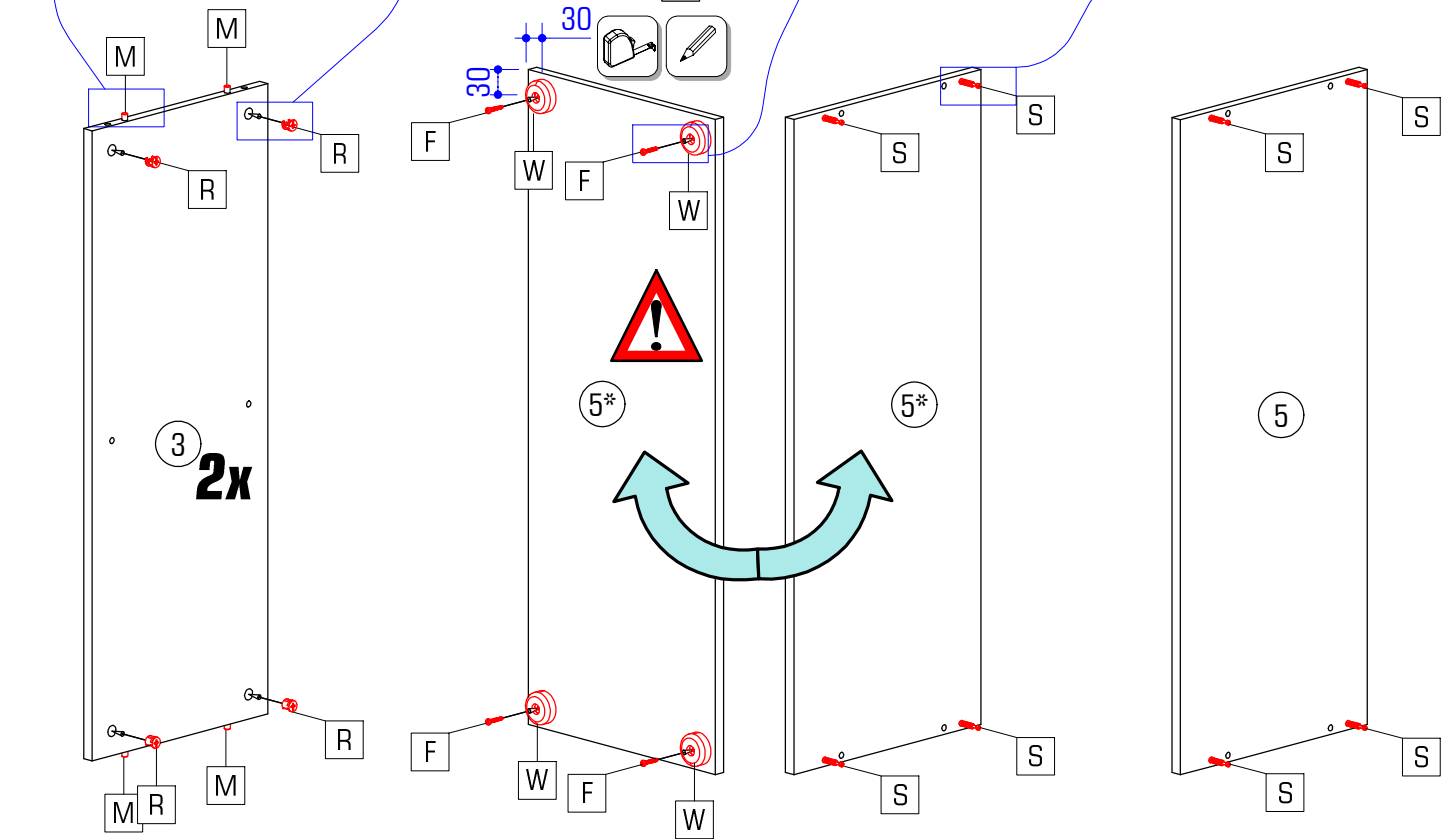
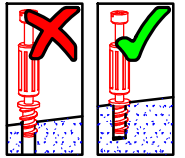
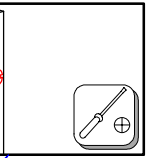
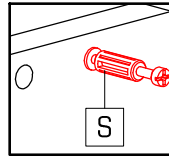
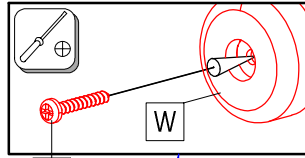
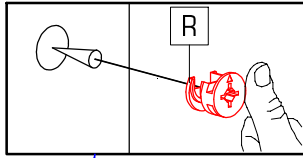
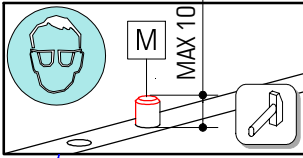
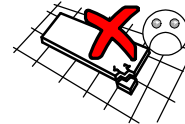
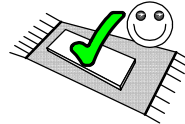

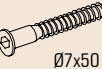
	J 4x
--	------

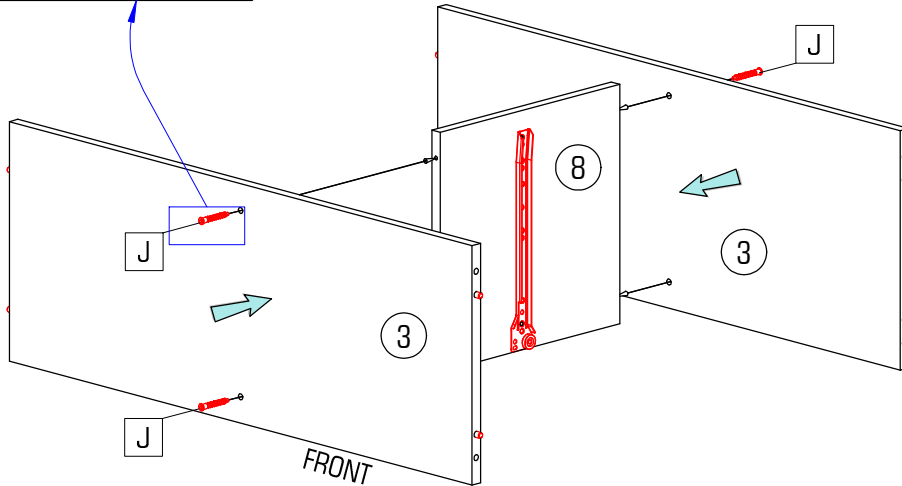
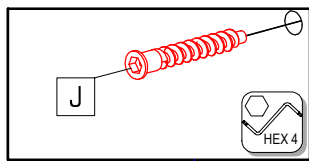

# 4/8 VILOT

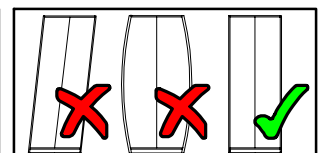
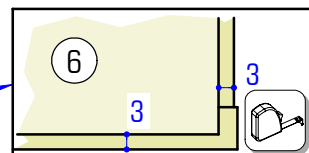
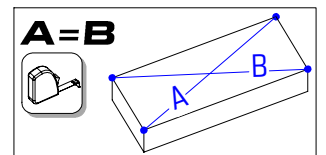
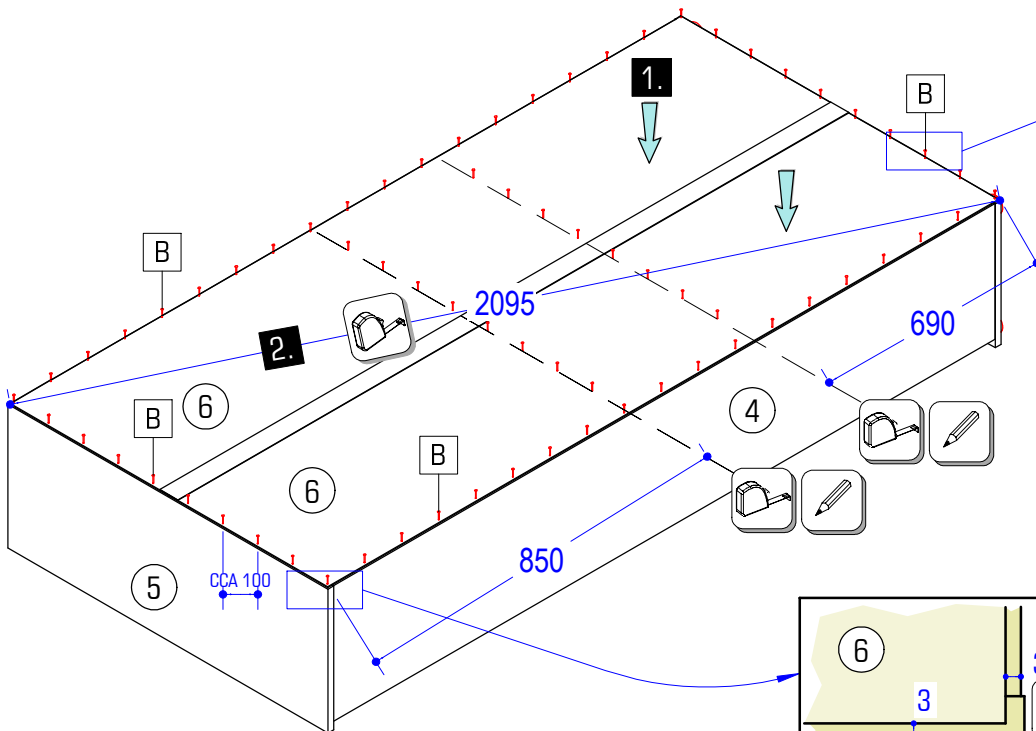
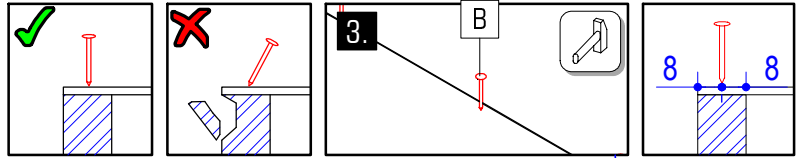
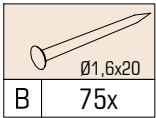
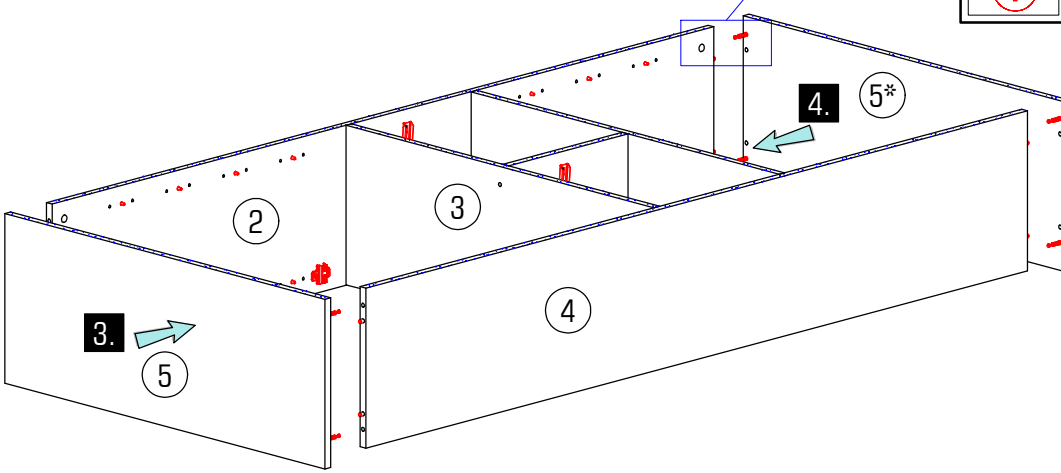
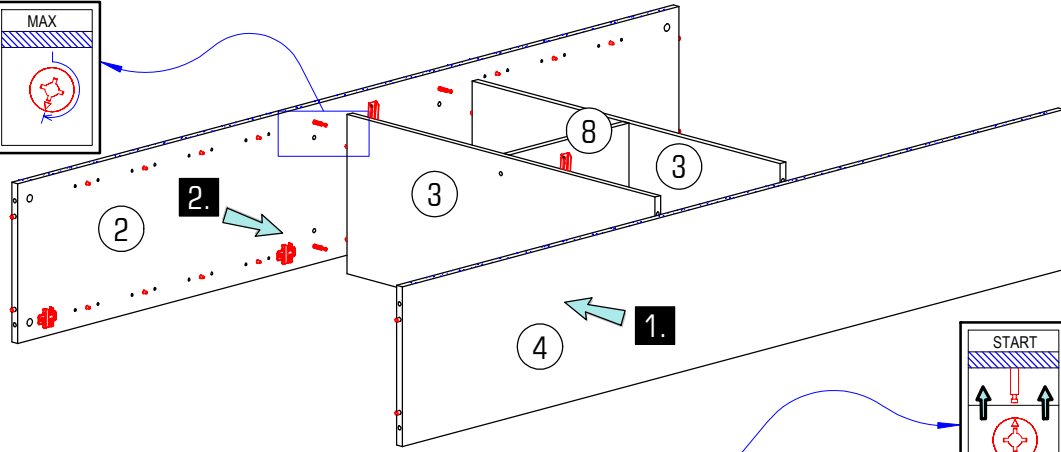
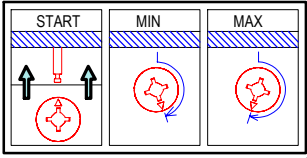

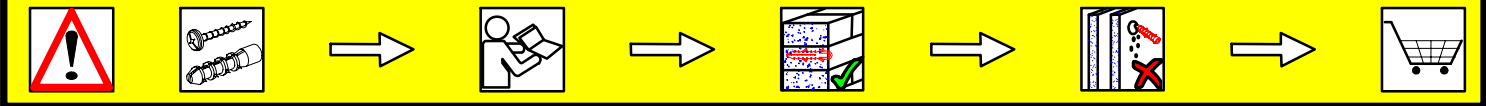

**PL** Uwaga! Ścianę należy sprawdzić przed montażem. Dołączone uniwersalne kolki rozporowe są odpowiednie tylko do stosowania w mocnych murach, takich jak beton lub cegła. Nie rób za pomocą kółków ozporowych murowanych, takich jak pustak, lekka kostka, powierzchnie takie jak płyty gipsowo-kartonowe lub inne systemy ram. Jeśli dotyczy, muszą to być określone kolki rozporowe być użytych! Są one dostępne w specjalistycznym sklepie niezgodność, producent / sprzedawca lub importer nie ponoszą odpowiedzialności.

**RO** Prudență! Zidul trebuie examinat înainte de asamblare prizele de perete sunt adecvatenumai pentru utilizarea în zidărie fermă, cum ar fi betonul bloc sau cărămidă. Nu folosiți zidăria zidurilor de perete, cum ar fi cărămida goală, blocul ușor, suprafețe cum ar fi gips-carton sau altă încadrare sisteme. Dacă este cazul, trebuie folosite anumite prize de perete! Acestea sunt disponibile la un magazin specializat (magazin de hardware) . În caz de nerespectare, producătorul / vânzătorul cu amănuntul sau importatorul nu își asumă

**SI** Pozor! Pred montažo preverite stanje stene. Priloženi univerzalni mozniki so izključno samo za uporabo na čvrstem zidovju, kot sta beton in opeka. Stenski mozniki se ne smejo uporabljati pri zidovju kot so votlina opeke, zidaki za lahko gradnjo, mavčne plošče ali druge okvirne gradnje. Pri teh zidovjih morate v danih primerih uporabljati posebne moznike. Ti so na voljo v specializiranih trgovinah (trgovinah z gradbenim materialom) Pri upoštevanju se s strani proizvajalca/trgovca in uvoznika ne prevzame jamstvo.

**DE** Achtung! Die Wandbeschaffenheit ist vor der Montage unbedingt zu prüfen. Die beigelegten Universaldübel sind ausschließlich nur zur Verwendung für festes Mauerwerk wie Beton/Ziegel. Die Mauerdübel dürfen nicht bei Mauerwerk wie Hohlraumziegel, Leichtbausteinen, Gipskartonplatte oder anderer Rahmenbauweise verwendet werden. Bei diesen Mauerwerken sind gegebenenfalls Spezialdübel zu verwenden! Diese sind in einem Fachgeschäft erhältlich. Bei Nichteinhaltung wird seitens Produzenten/Händler und Importeur keine Haftung übernommen.

**HR** Pažnja! Prije montaže obvezno provjerite svojstvo zida. Priložene univerzalne tiplje namijenjene su isključivo za masivne zidove od betona/opeke. Tiplje za masivne zidove ne smiju se koristiti za zidove kao npr šupljina opeka laki sastavni elementi, gips-kartonske ploče ili drugi modularni načini gradnje. Za te zidove potrebne su eventualno specijalne tiplje! Iste su dostupne u specializiranim trgovinama građevinskim materijalom. U slučaju nepridržavanja prethodno navedenih napomena, proizvođač/trgovac i uvoznik ne preuzimaju odgovornost!

**HU** Vigyázat! Szerelés előtt a falfelületet feltétlenül vizsgálja meg. A mellékelt univerzális tiplj kizárólag stabil falazathoz használható mint például beton/tégla. A fali tiplje nem használható könnyű építőkövekhez, üreg tégla, gipszcarton lapokhoz vagy más fávázás építményekhez. Ezekhez a falfelületekhez csak speciális tiplik használhatóak, melyek szaküzletekben (barkácsruházakban) beszerezhetőek. Fentiek figyelmen kívül hagyása esetén a gyártó/kereskedő vagy forgalmazó nem vállal felelősséget.

**EN** Caution! The wall must be examined before assembly. The included universal wall plugs are only suitable for using in firm masonry such as concrete block or brick. Do not using the wall plugs masonry such as hollow brick, lightweight block, surfaces such as gypsum plasterboard or other framing systems. If applicable, particular wall plugs must be used! These are available at a specialised store (hardware store). In case of non-compliance, the manufacturer/retailer or importer do not assume liability.

**CZ** Upozornění! Před montáží je nutné zkontrolovat stav stěny. Priložené univerzální hmoždinky jsou určeny pouze k použití pro pevné zdivo jako beton/cihly. Hmoždinky do zdi se nesmí používat u dutinová cihla, zdiva jako porovité stavební kámen, sádrokartonová deska nebo jiný měkký materiál. U těchto zdiv jsou nutné použít speciální hmoždinky! Jsou k dostání v speciálních prodejnách se stavebním materiálem. Při nedodržení těchto pokynů výrobce/prodejce a dovozce neručí za způsobené škody.



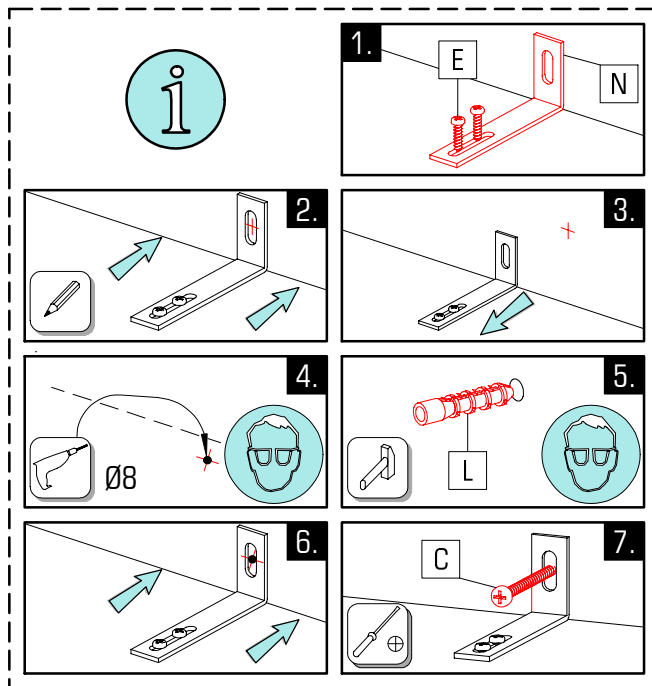
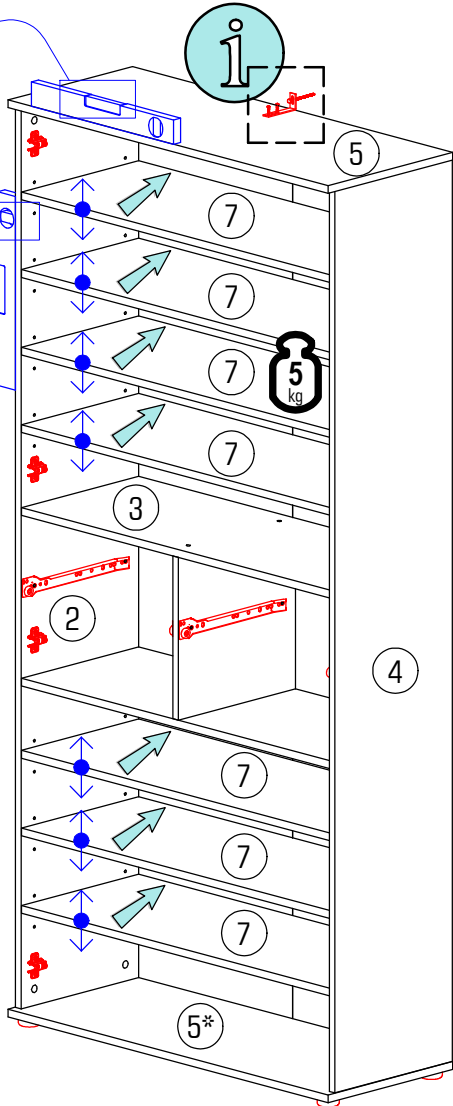
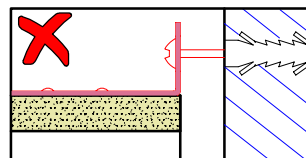
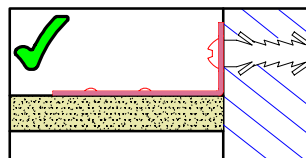
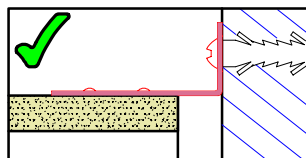
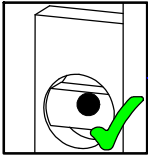
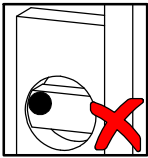
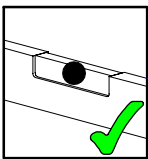
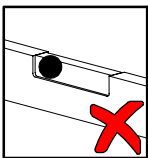

**SK** Upozornenie! Pevnosť steny sa musí pred montážou bezpodmienečne skontrolovať. Priložené univerzálne hmoždenky používajte jedine pre pevné murivo ako je betón/tehla. Hmoždenky sa nesmú používať v prípade ľahkého stavebného muriva, múry, tehla, sádrokartónová doska, alebo iných konštrukcií rámu. U týchto stien je nutné použiť špeciálne hmoždenky! Tieto je možné dostať v špeciálnych predajniach so stavebným materiálom. Pri nedodržaní pokynov nepreberajú výrobca/predajca a dodávateľia zodpovednosť za vzniknuté škody.

Ø4x70	Ø3,5x16	Ø8	
C 1x	E 2x	L 1x	N 1x







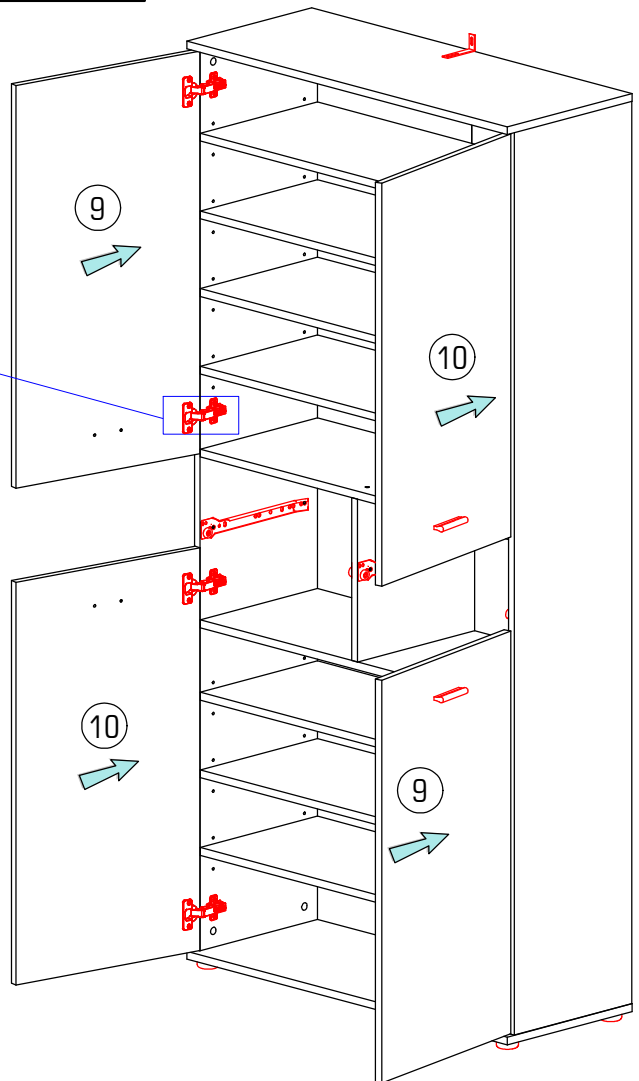
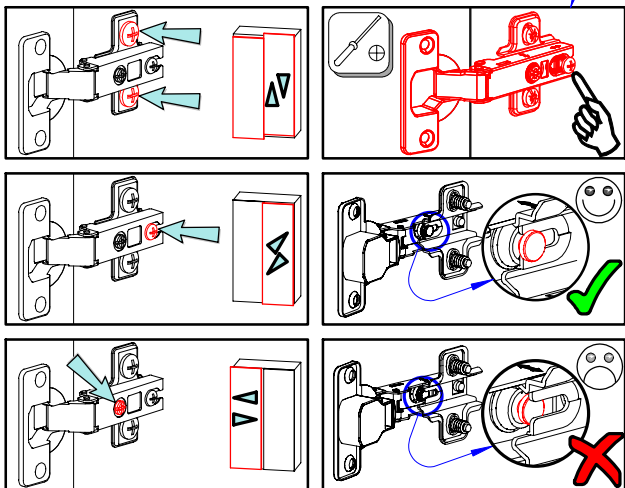
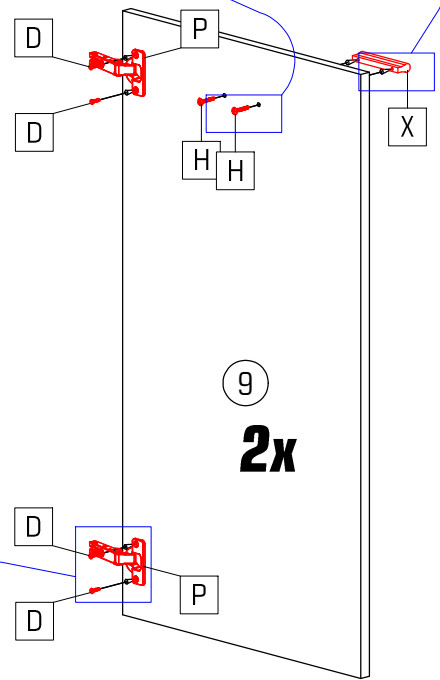
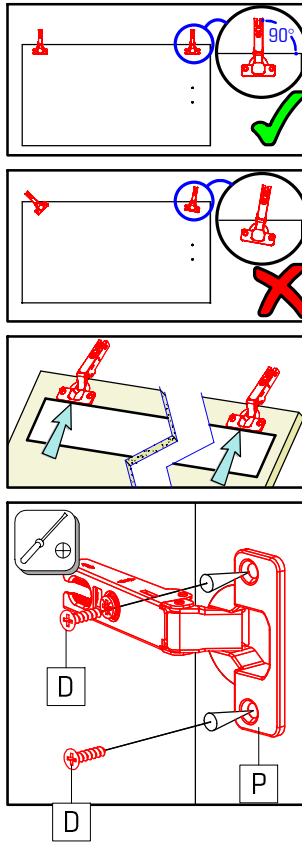
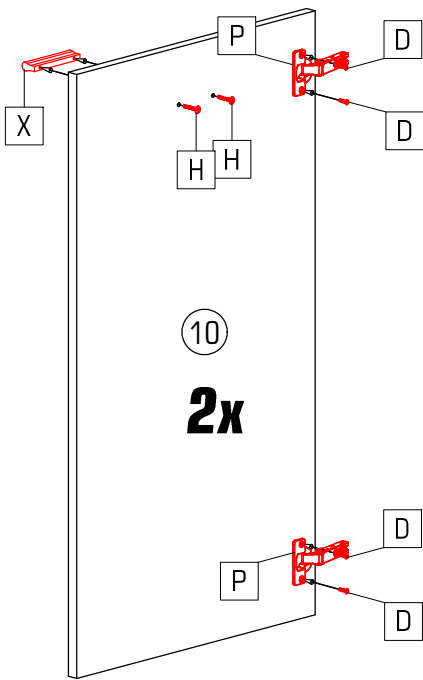
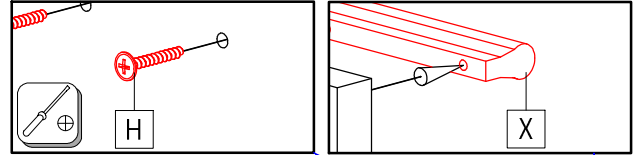

- SK VÝSTRAHA
- CZ VAROVÁNÍ
- HR UPOZORENIE
- DE WARNUNG
- HU FIGYELEM
- PL OSTRZEŻENIE
- RO AVERTIZARE
- EN WARNING
- SI OPOZORILO

# 6/8 VILOT

			
Ø3,5x15	Ø4x30	L=84	
D 16x	H 8x	P 8x	X 4x

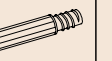

							
D	E	H	J	R	S	U	X
12x	6x	4x	8x	8x	8x	2x	2x
						L=300	L=84

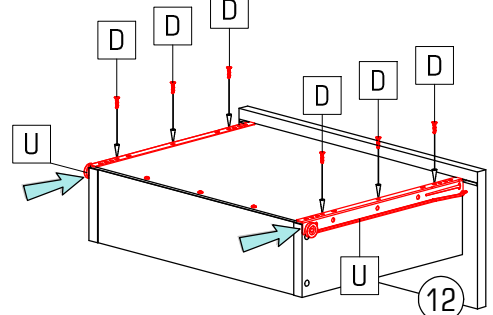
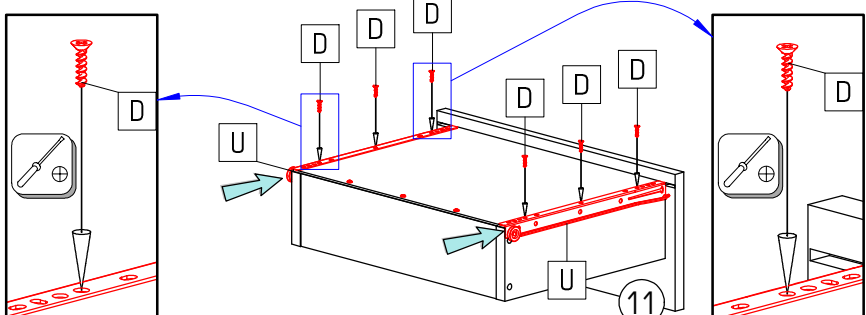
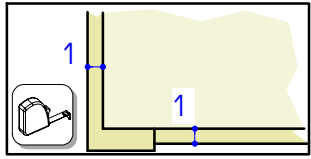
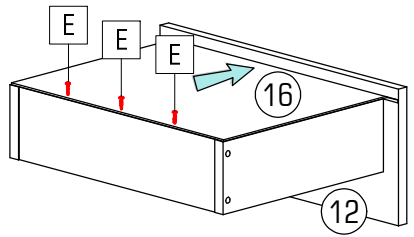
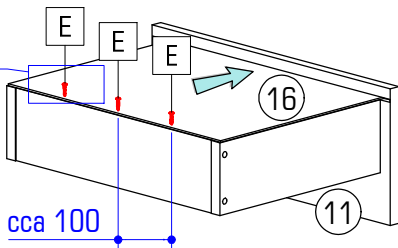
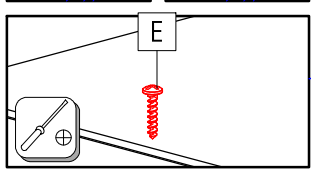
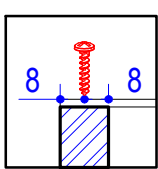
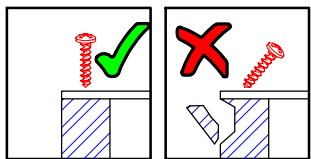
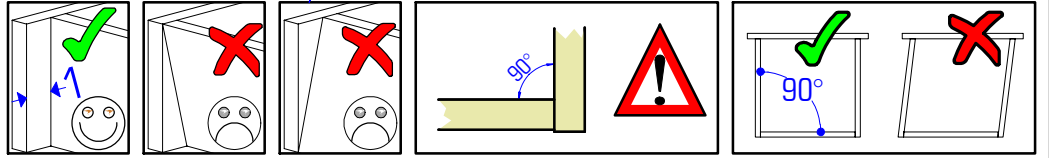
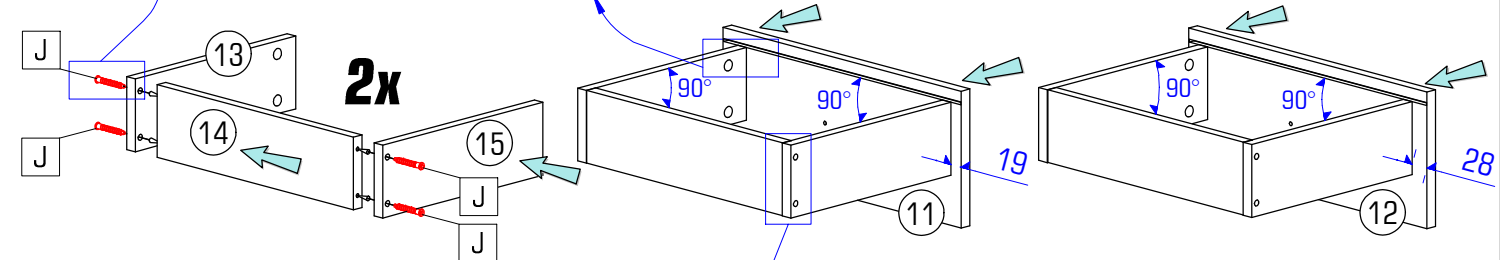
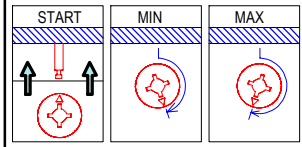
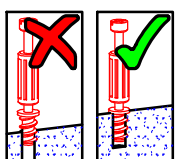
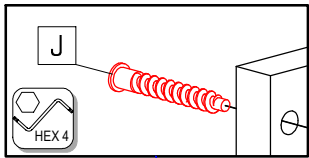
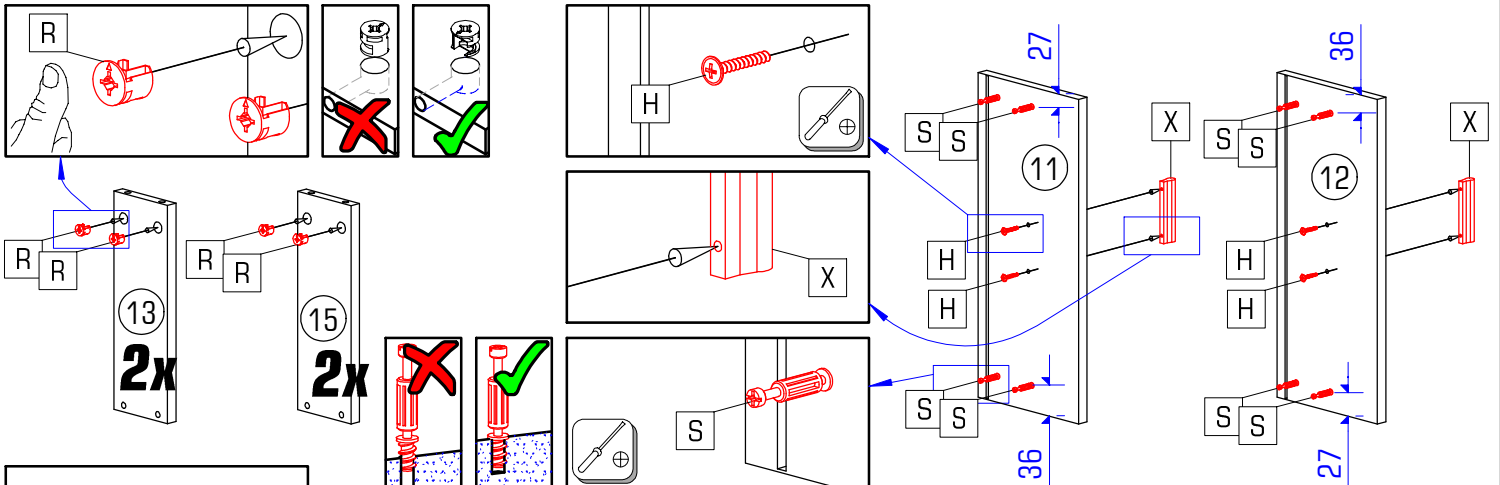

# 8/8 VILOT

